



# P855-288

Next Generation High Mast LED  
Luminaire with variable geometry  
STAR-optic®



This luminaire complies with ETL guidelines for White Light Emitting Diode Lighting Units and is eligible for the Enhanced Capital Allowance (ECA) scheme.



**P855-288** a highly innovative, high mast LED luminaire with 360° rotating STAR-optic®. The functional yet compact design delivers exceptionally powerful optical and thermal performance, whilst maintaining a low weight and wind area.

P855-288's wide range of optical distributions coupled with 360° rotation delivers unlimited freedom in lighting design regardless of luminaire orientation, while optimising energy efficiency for even the most challenging scheme.

It is the ultimate solution to replace traditional High Mast HID sources with



*This luminaire complies with ETL guidelines for White Light Emitting Diode Lighting Units and is eligible for the Enhanced Capital Allowance (ECA) scheme.*

## FEATURES

- STAR-optic® system delivers 360° variable photometry
- PMMA optic minimises light at angles
- Slim, elegant and state-of-the-art design
- High flux density and efficacy LED
- Powerful output up to 61,220 lm
- Superior luminaire efficacy up to 160 lm / W
- Wide range of light distributions
- Low lumen depreciation (L95 at 90,000 hours) at full power
- User friendly installation
- Maximised savings on energy and maintenance costs
- Minimal total cost of ownership
- Up to G6 glare rating. Dark sky friendly, no upward light
- Flexible and intelligent lighting control options
- Lightweight and low windage allowing retrofit onto most existing masts
- IP66 ingress protection for Optical & Driver Compartment
- 100% recyclable, low carbon footprint

## A NEW ERA

Compared to the classic P655, the new P855-288 offers wide choice of optics and lumen packages, it has 30% less wind area whilst maintaining the same weight and, can therefore be retrofitted on existing masts with ease.

	P655 (400W SON)	P855-288
Weight	16kg	17kg
Size ( L x W x H )	750 x 470 x 189	925 x 485 x 133
Wind Area	0.120m <sup>2</sup>	0.085m <sup>2</sup>
Luminaire Luminous Flux	39,000lm	61,220 lm
Luminaire Efficacy	98 lm/W	149- 160 lm/W
Photometric Options	Single reflector	10+ Lenses



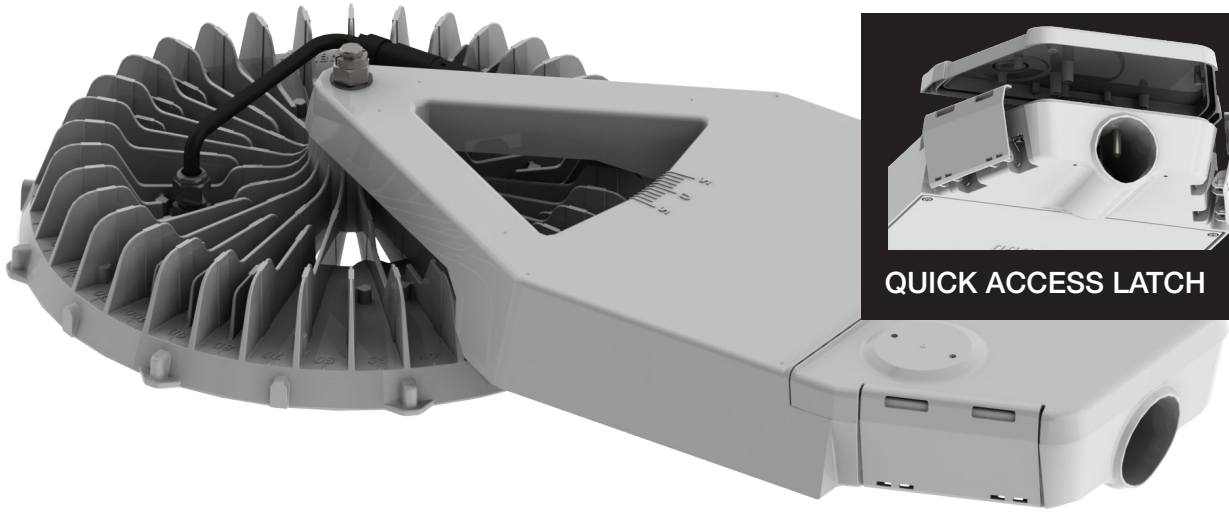

QUICK ACCESS LATCH

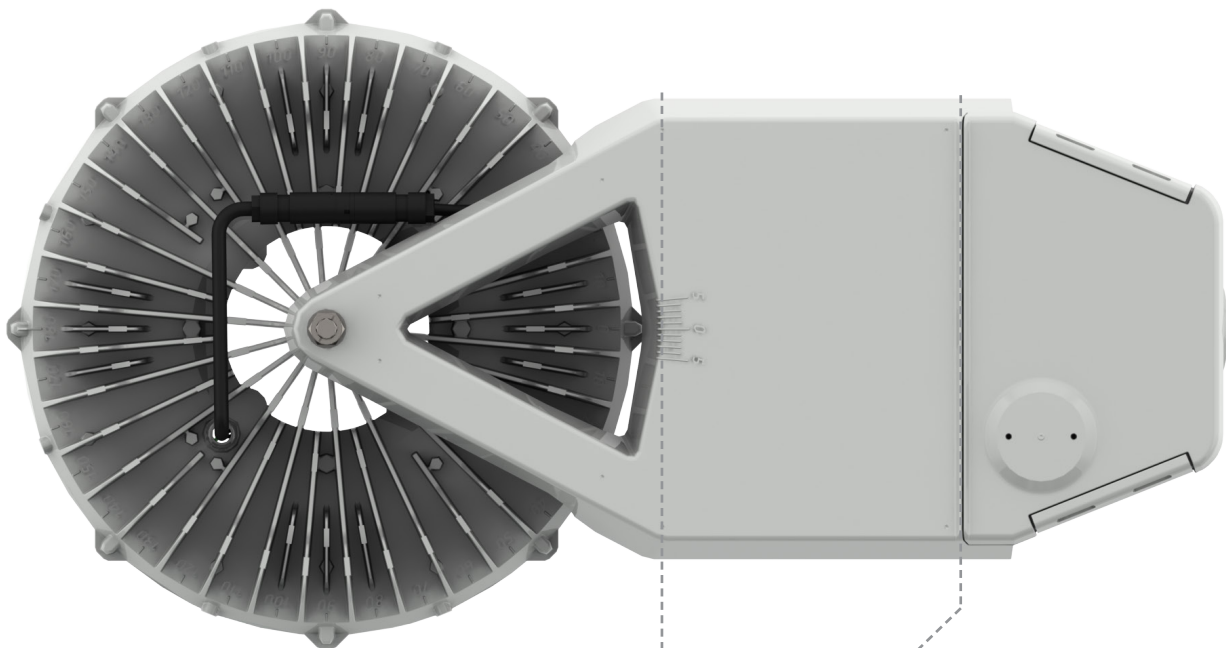

### STAR-optic® Module

- 360° STAR-optic® system
- Single security fixing for module
- Plug and play power connection
- On site upgrade
- IP66

### Driver Compartment

- Cool to maximise lifetime of the drivers
- Bottom opening for optimum ingress protection
- No access required by maintenance contractor throughout life
- IP66

### Connection Compartment

- Separated for easy installation
- Quick, tool-less access to:
  - Luminaire spigot fixing
  - Supply termination
  - Fit and wire PECU / CMS node
- IP54 with open drainage to prevent water build up minimising contractor risk

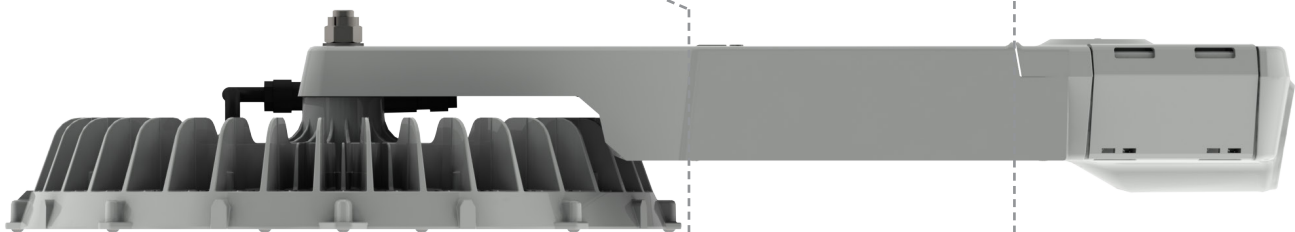

## STAR-optic® SYSTEM

The unique STAR-optic® system is designed to provide 360° variable photometry tailored for LED lighting operating in high ambient temperatures. The PMMA optics offer many optical distributions to suit Roads, Floodlight and Amenity lighting while maximising LOR and minimising the light spill. Flat glass ensures no upward light and is suitable for using in harsh environments. The result is a highly efficient system with powerful output for high mast applications. The light module can be easily replaced on site for servicing or upgrading.

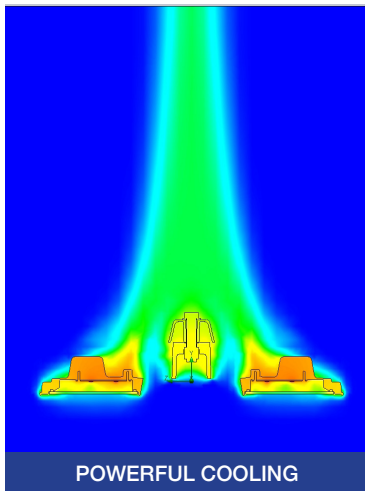
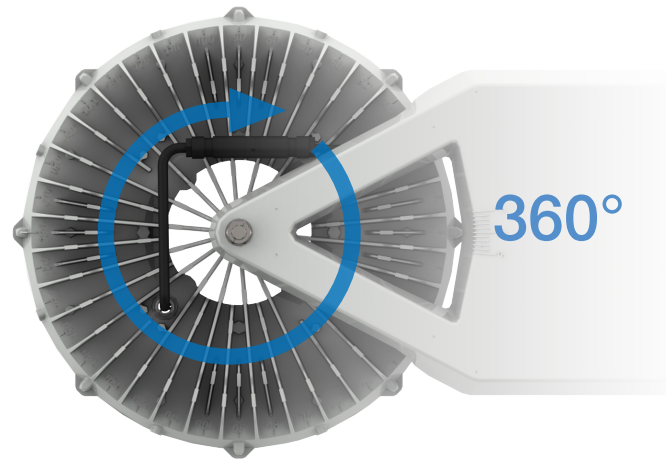

### High Power CSP LEDs

- Superior light output
- High flux density & efficacy
- Proven reliability
- Tight CCT control (4000K)
- Colour rendering index > 70

### FLAT GLASS

- Vandal resistant toughened glass
- Increased light transmission
- Dark sky friendly (minimises sky glow)
- Suitable for harsh environment
- IP66 sealed, easy cleaning externally

### PMMA LENSES

- 10+ distributions
- Exceptional uniformity

### AIR VOID

- Minimises heat transfer from the optical module to the Driver compartment
- Allows air flow all around optical module for maximised cooling

### HOUSING

- Aluminium high pressure die cast body
- Unique design that optimises thermal performance
- Corrosion resistant materials
- Finish polyester powder coated for long life
- Sustainable and recyclable

## THERMAL MANAGEMENT

P855-288 is powerful while compact and efficient, thanks to its design and unique thermal management.

Aerodynamic vents created by the vertical fins at the center void are designed to accelerate natural convection. Hot air converges smoothly into a fast laminar flow, quickly removing heat from the luminaire, increasing the performance of LEDs and drivers.

Fin profiles are designed to minimise weight while allowing an even thermal dissipation for all LEDs.

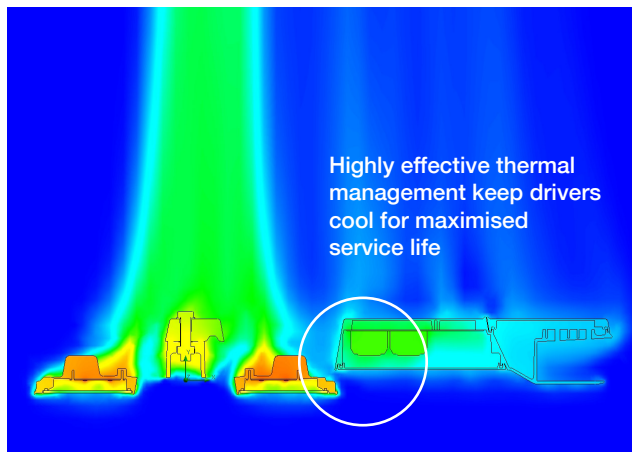

Air and luminaire temperature results from CFD

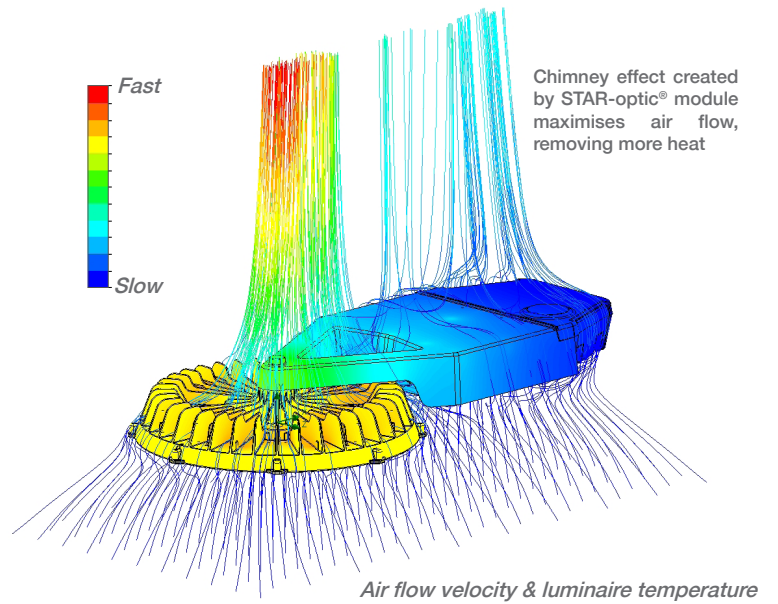

The complete separation of the driver compartment from LEDs keeps the driver very cool, significantly increasing the driver's service life in high ambient operating temperatures.

P855-288 can be used at maximum power in an environment of 45°C while still achieving low lumen depreciation and long life (L85 @ 100,000 hours)

## LIGHT DISTRIBUTION

P855-288 offers a wide choice of optics and lumen packages. The optics include both road, flood and amenity distributions which, coupled with 360° rotation, allow even the most challenging schemes to be effectively lit with maximum energy efficiency.

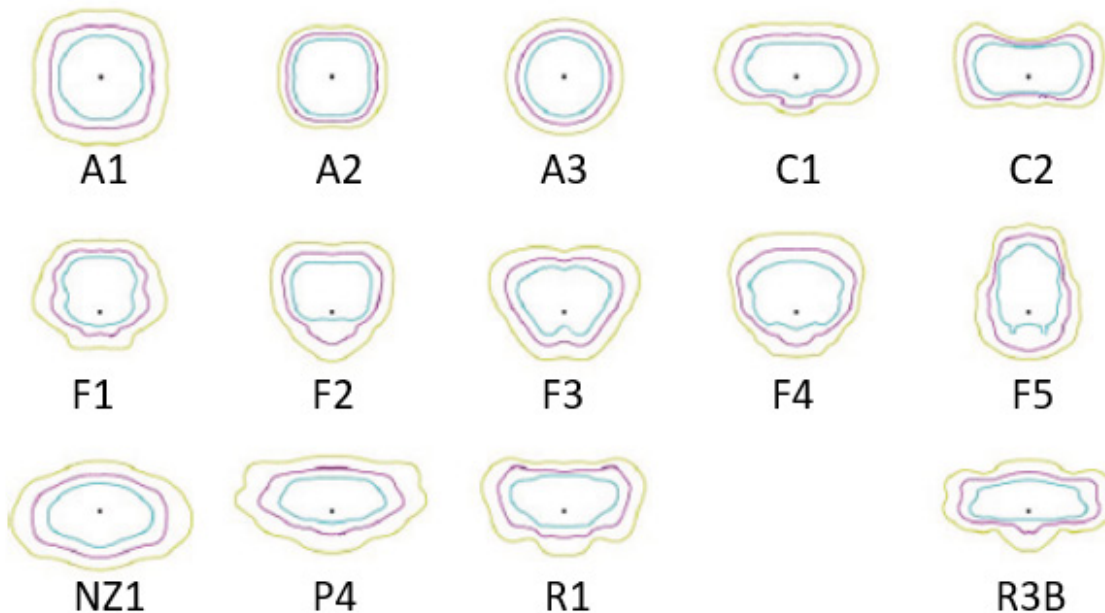

# P855-288 SPECIFICATION

Light Source	High Power CSP LEDs
Number of LEDs	288
Power Consumption	104 - 411W
Luminaire Luminous Flux	16,500 ~ 61,220 lm
Luminaire Efficacy	149 - 160 lm/W ( Ta = 25°C )
Driver Current	200mA ~ 1000mA ( in 25mA steps )
Lumen Maintenance Output *	L85 @ 100,000 hrs ( Ta = 45°C ) L90 @ 100,000 hrs ( Ta ≤ 40°C ) L95 @ 90,000 hrs ( Ta ≤ 25°C )
Operating Temperature	-40°C to +50°C
Weight (Total)	17kg
Correlated Colour Temperature	Neutral white, 4000K (3000K option)
Glare Rating	up to G6
Colour Rendering Index	> 70
Optical Cover	Flat Glass
Electrical Class	I
Control System Input	DALI • Switch dim
Surge Protection	10 kV Comm. Mode 6 kV Diff. Mode to IEC 61000-4-5;
Lighting Regulation	Mini Photocell • NEMA Socket • Wireless CMS options
Installation Height	15 ~ 40m
Installation	Ø 42 - 60mm x 100mm Side Entry
Accessories	Bird spikes • Light Shields • Solar Shield
Material	High pressure die cast aluminium (housing)
Finish	Polyester powder coat cured under heat
Colour	Light grey ( RAL 7035 ), other RAL colours available on request
Ingress Protection	IP66 (STAR-optic® module and driver compartment) IP54 (connection compartment)
Wind Area	0.085m <sup>2</sup>

\* Lumen depreciation calculated up to 100,000 hours using IES TM-21 method.

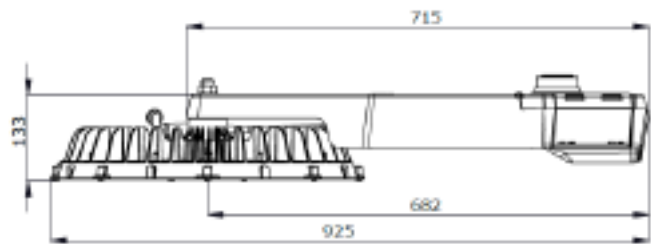
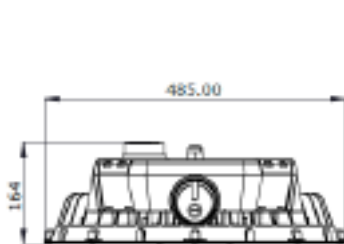

Charles House  
Gt. Amwell, Ware  
UK, SG12 9TA  
+44 (0) 1920 860600  
enquiries@cuphosco.com  
www.cuphosco.com

Copyright© 2021 CU Phosco Lighting. Due to constant development, details in this brochure are subject to change at any time. Contact us for the latest information.